



## Bernie Bear's Origami Firefighter's Helmet

Follow the instructions to fold a firefighter's helmet out of a single piece of paper.

Challenge your adults at home to try it - I bet you do better than they do!

You will need a glue stick, A3 paper and felt tip pens.

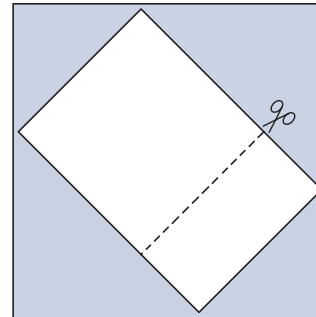

1. Take a sheet of paper and cut a strip off to make a square as shown.

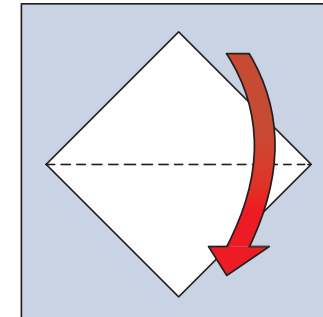

2. Fold the square in half along the dotted line.

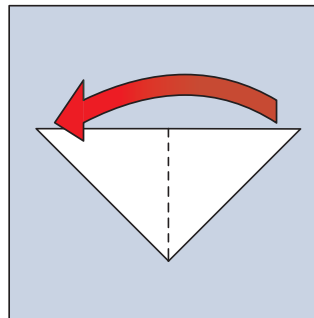
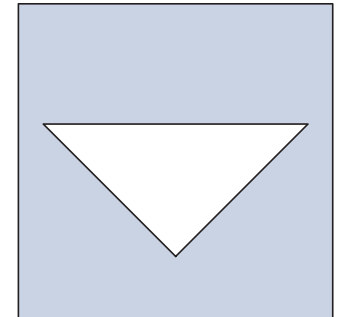

3. Fold along the dotted line to make a crease as shown. Then fold back again.

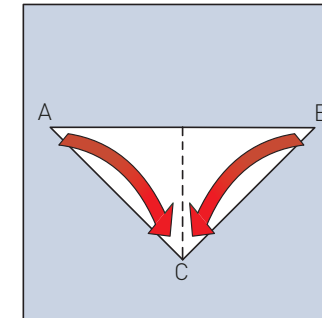
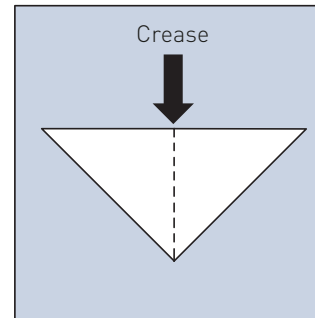

4. Fold corner A towards corner C and then fold corner B towards corner C.

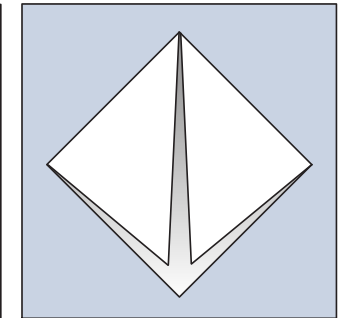



## Bernie Bear's Origami Firefighter's Helmet

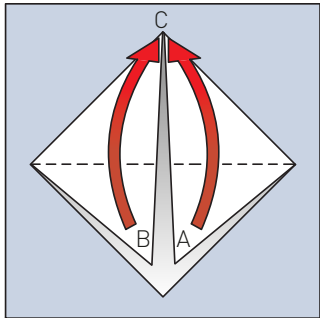

5. Fold corner A to meet corner C and then fold corner B to meet corner C.

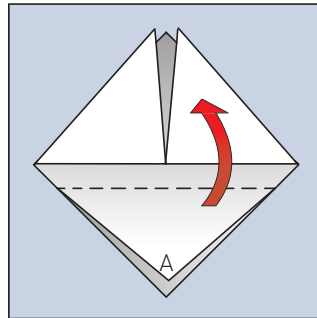
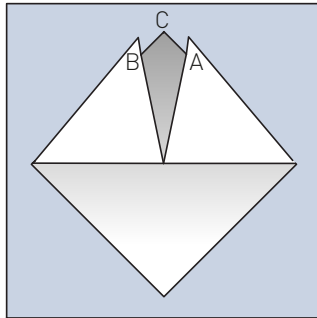

6. Fold the top flap A along the dotted line.

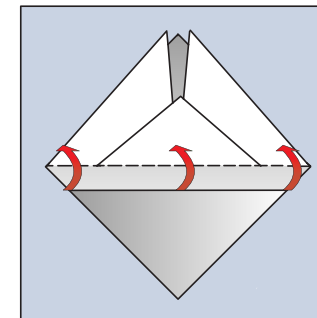
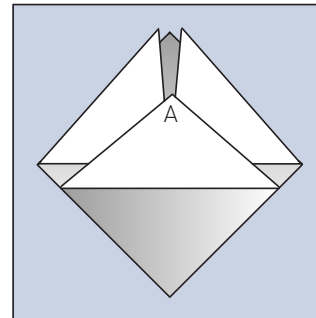

7. Make a crease along the dashed line then fold as shown.

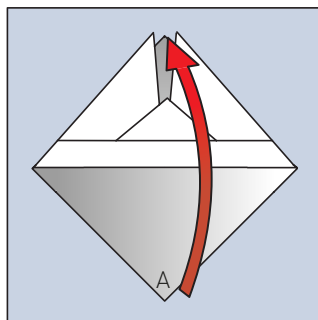
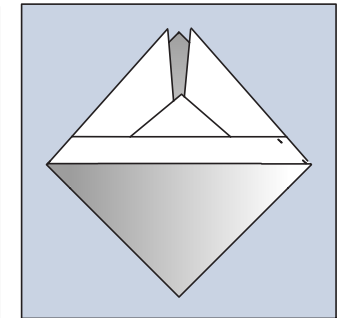

8. Fold corner A as shown and fold back again.

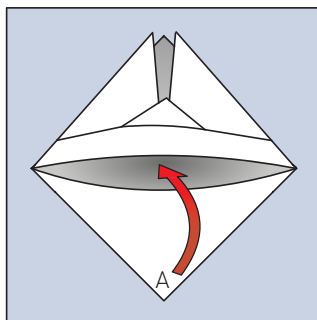
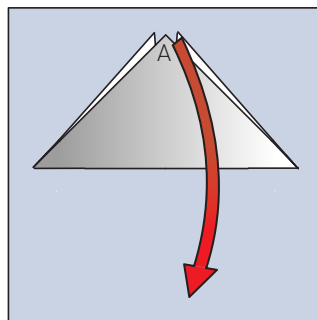

9. Tuck corner A inside the helmet as shown.

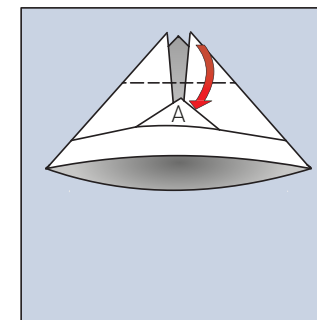
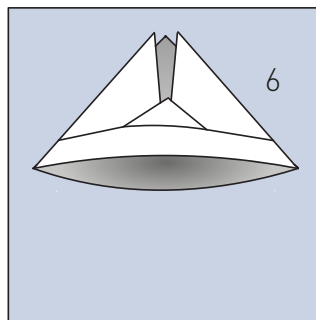

10. Fold the pointed top of the helmet over and tuck it under triangular flap A as shown.

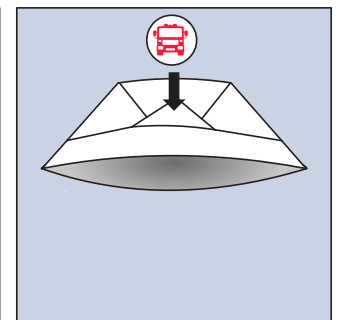

11. Stick on the StayWise Fire Icon (left) and colour your helmet in!

